

Extended View

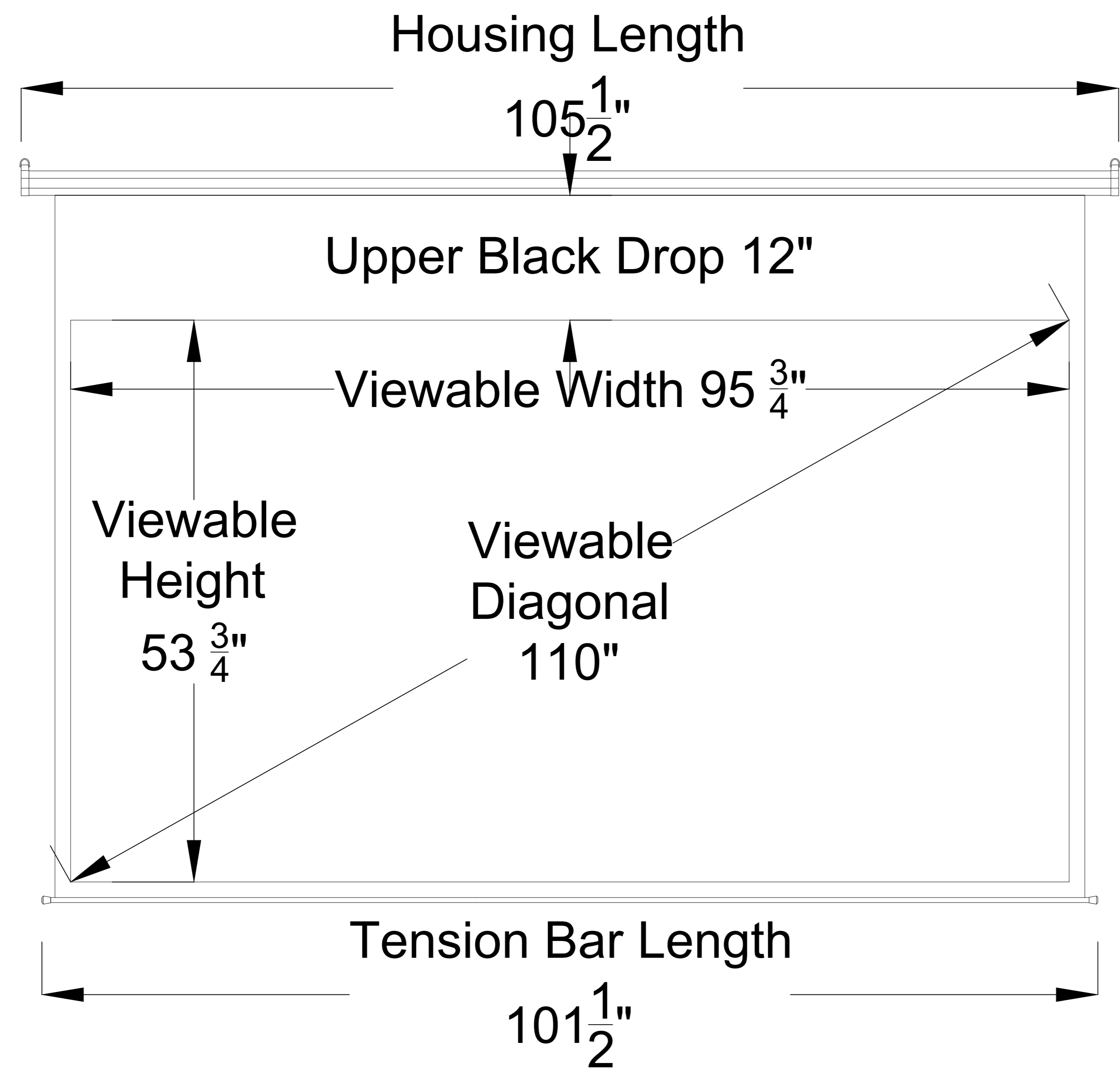

Retracted View

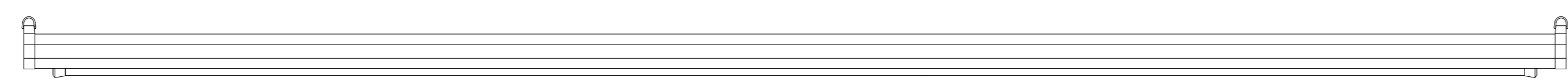

Title: Juno Motorized Projection
Screen 110" 16:9

Product Model: EV-J-110-1.0

Scale 1:1

Page 1 of 2

Detailed Side View

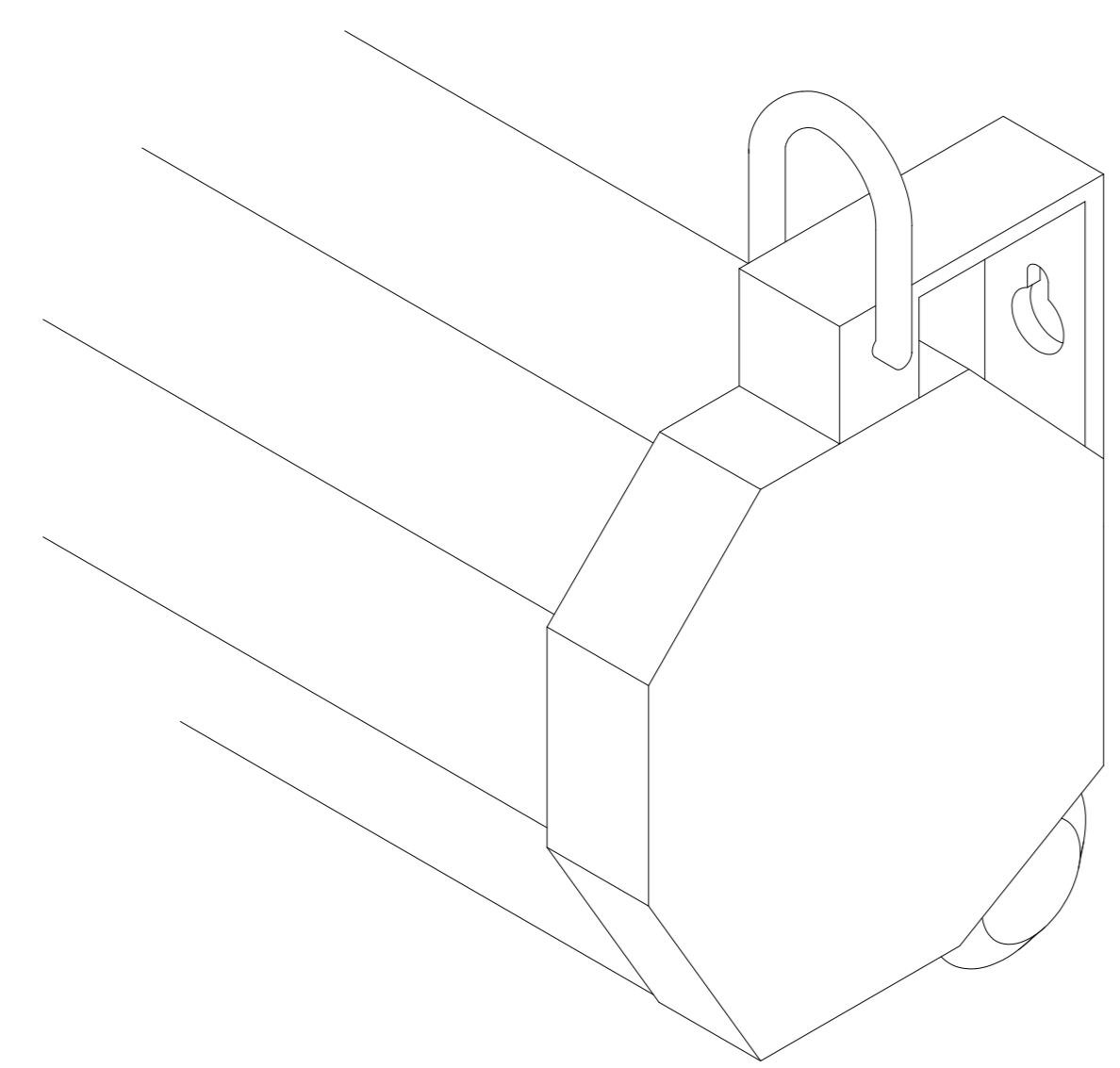
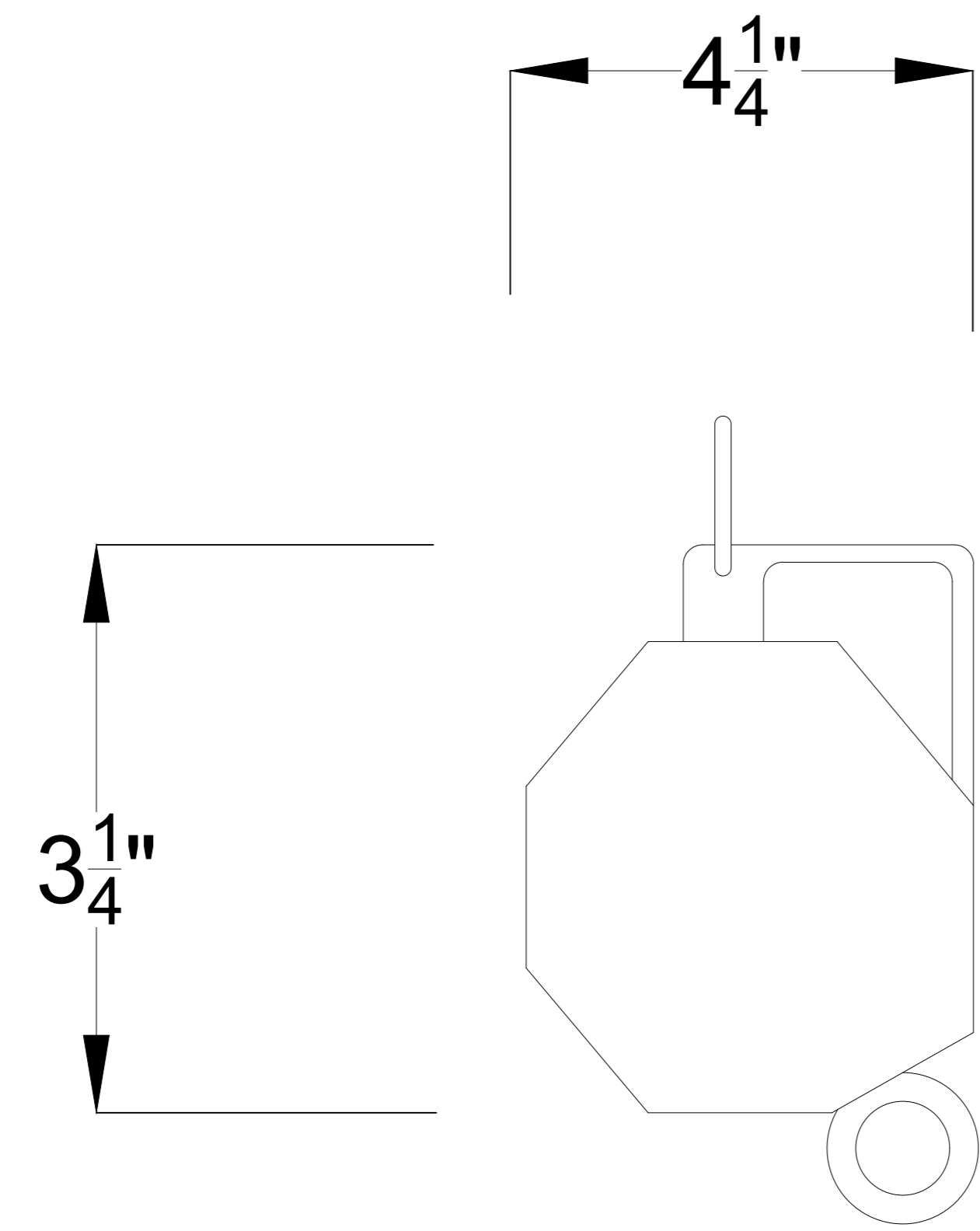

Mounting Methods

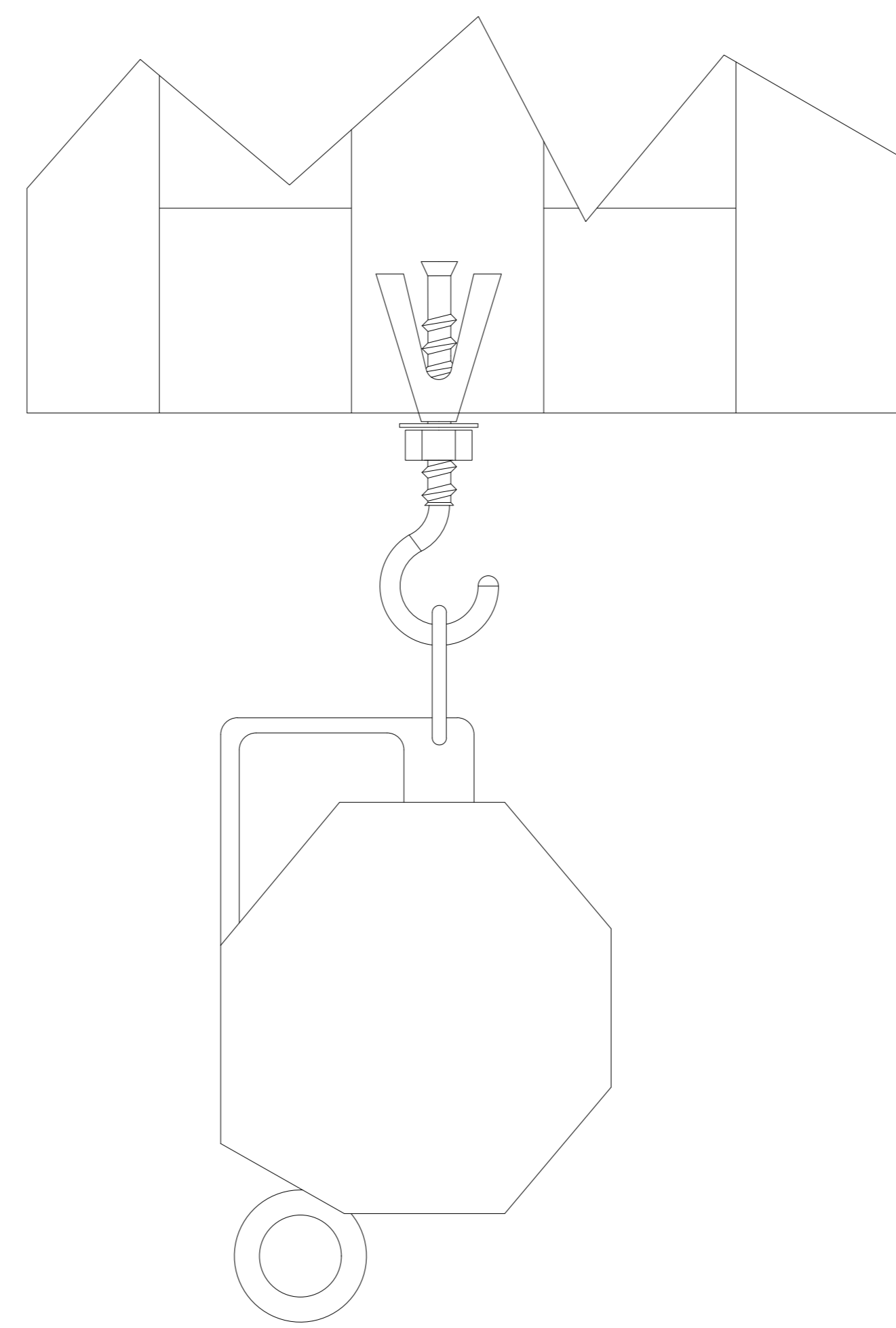

Ceiling Mounting

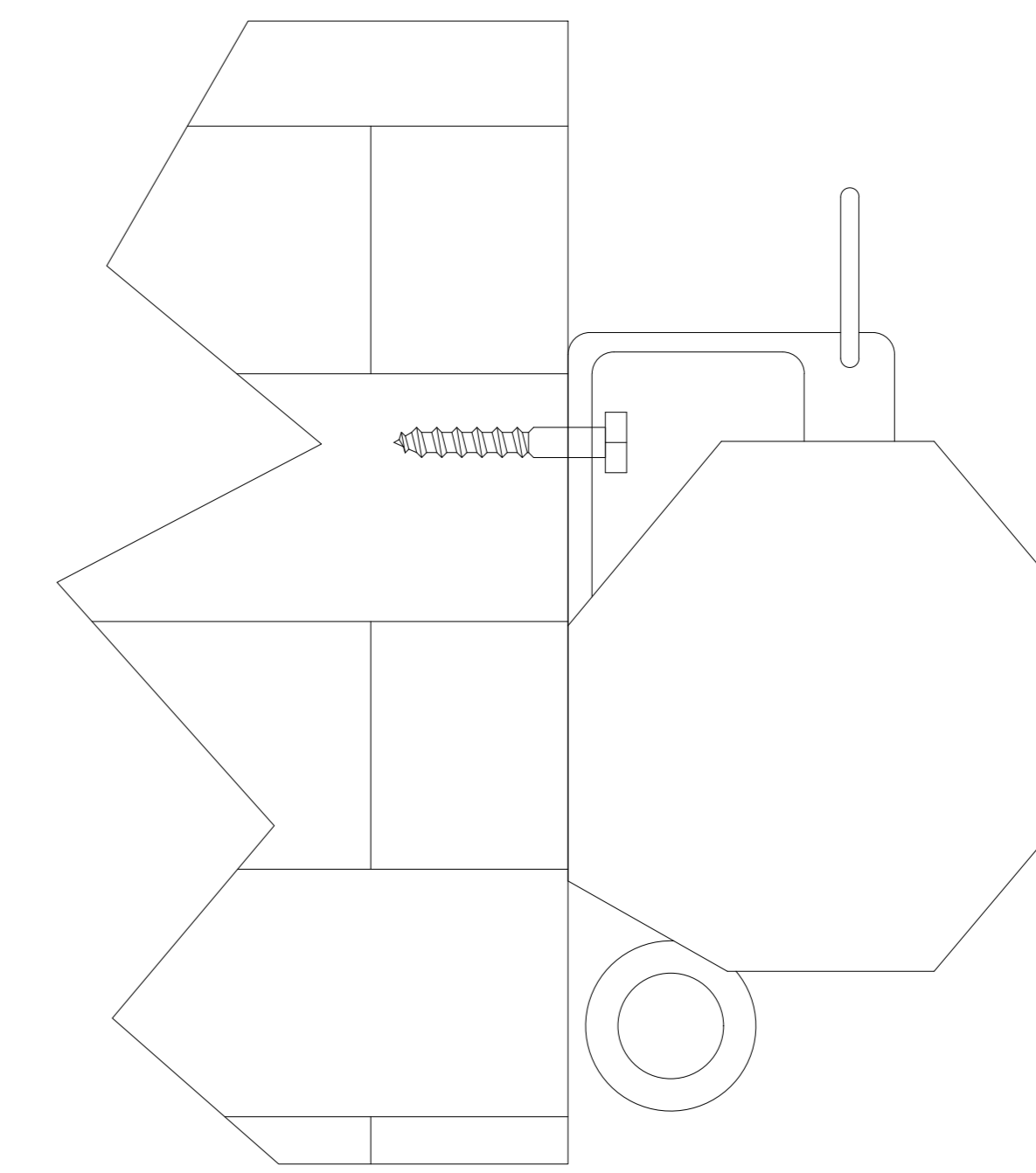

Wall Mounting



Title: Juno Motorized Projection
Screen 110" 16:9

Product Model: EV-J-110-1.0

not to scale

Page 2 of 2