

Extended View

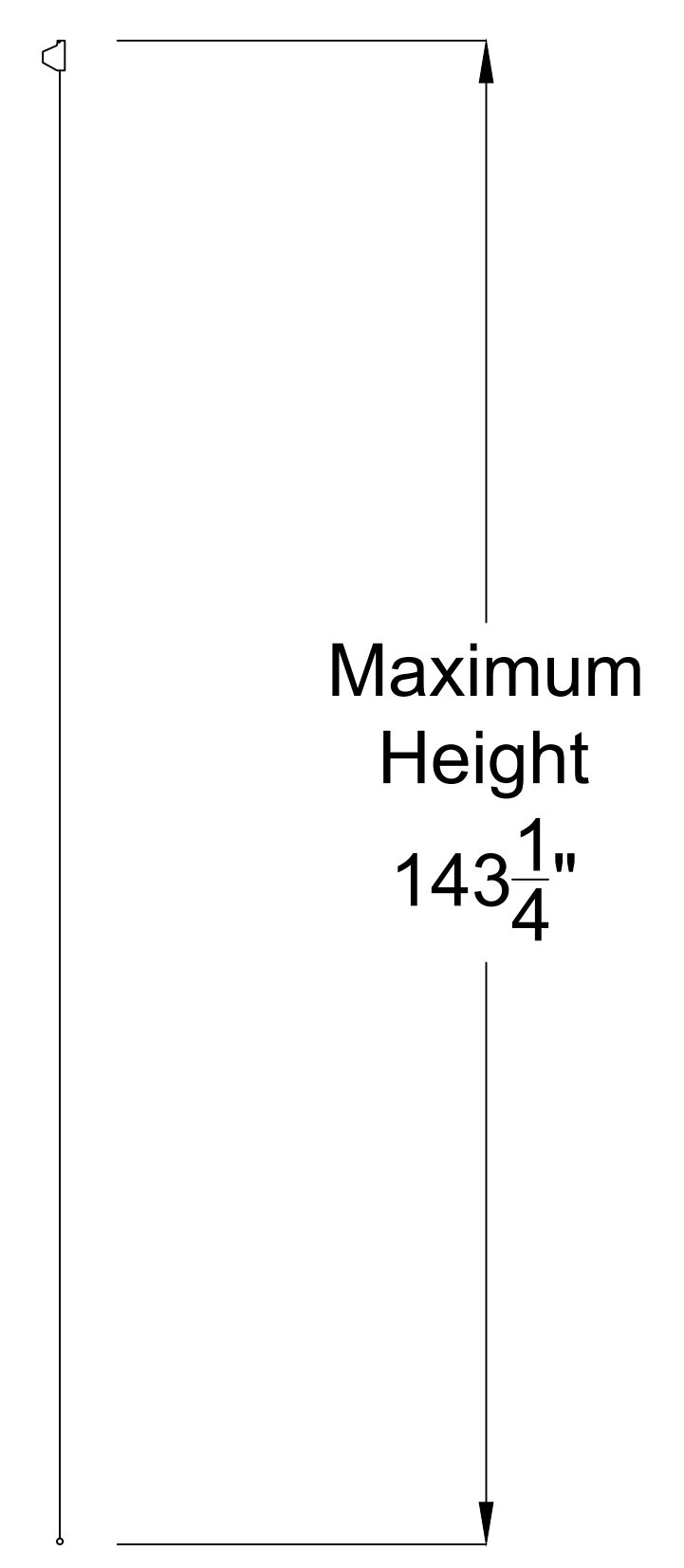

Retracted View

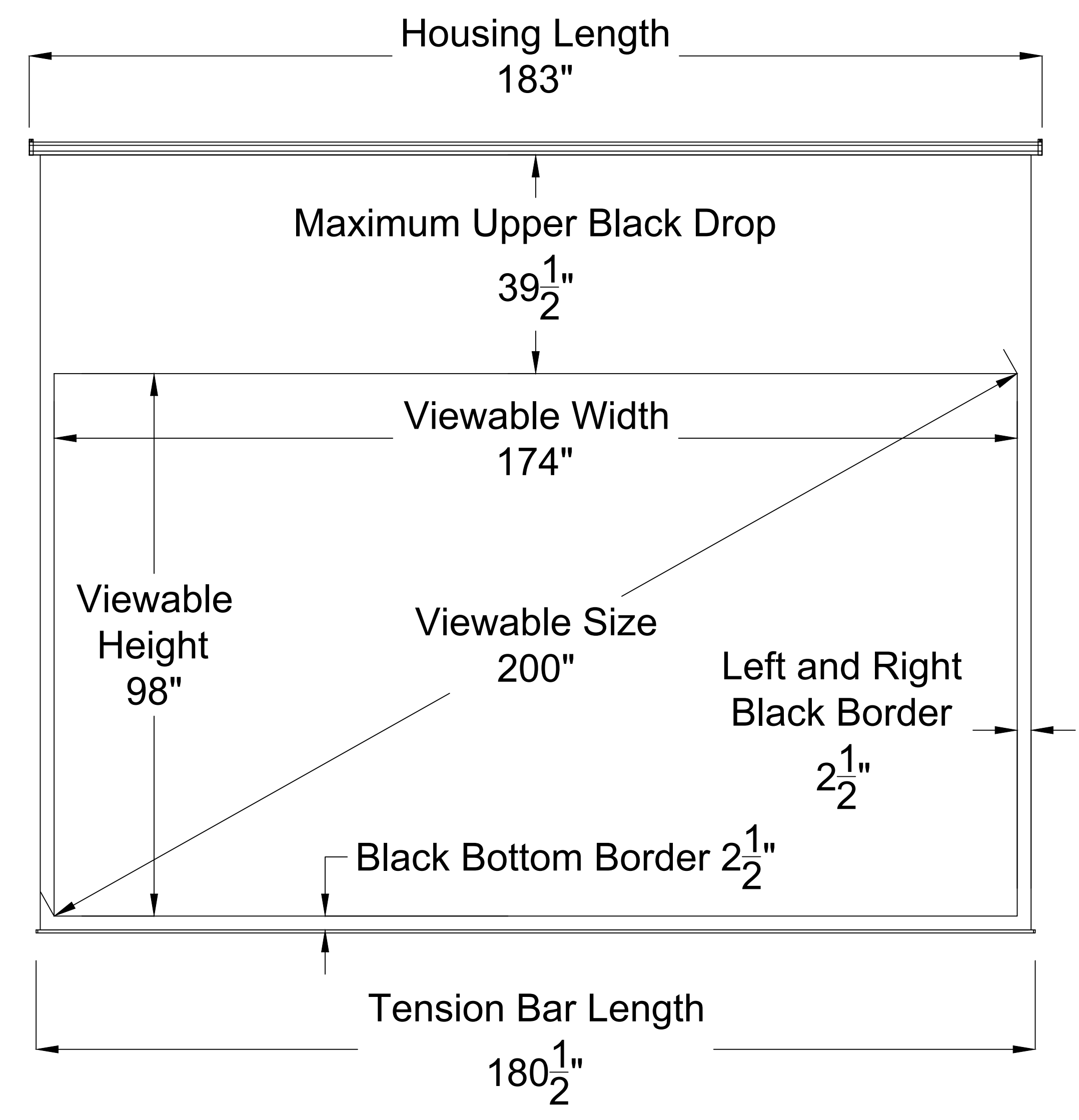

Professional Large Motorized
Screen 200" 16:9

Product Model: EV-LM-200-1.2

Scale 1:1

Page 1 of 2

Left-handed Housing

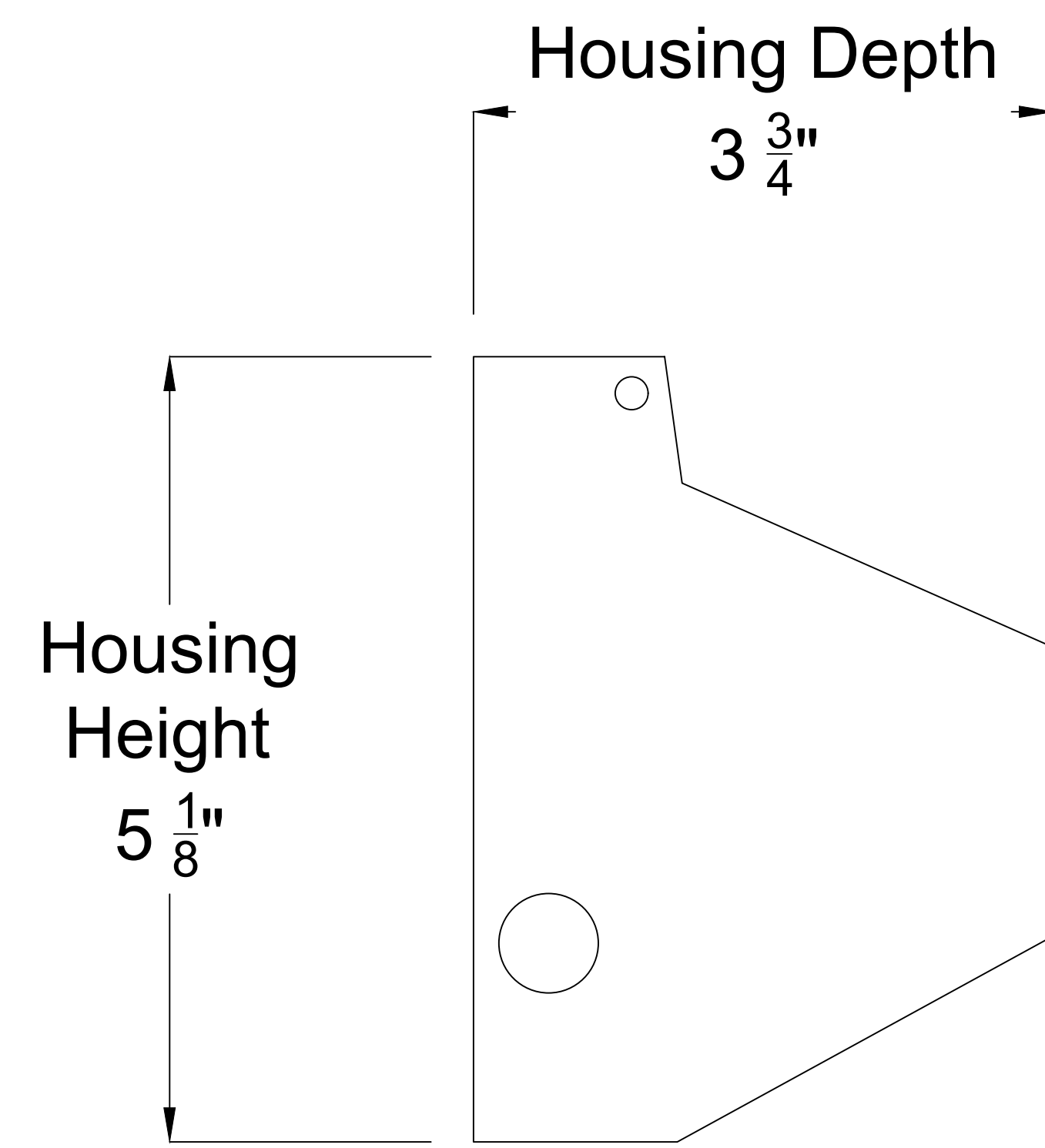

Wall Mounting

Screen can be directly secured to wall

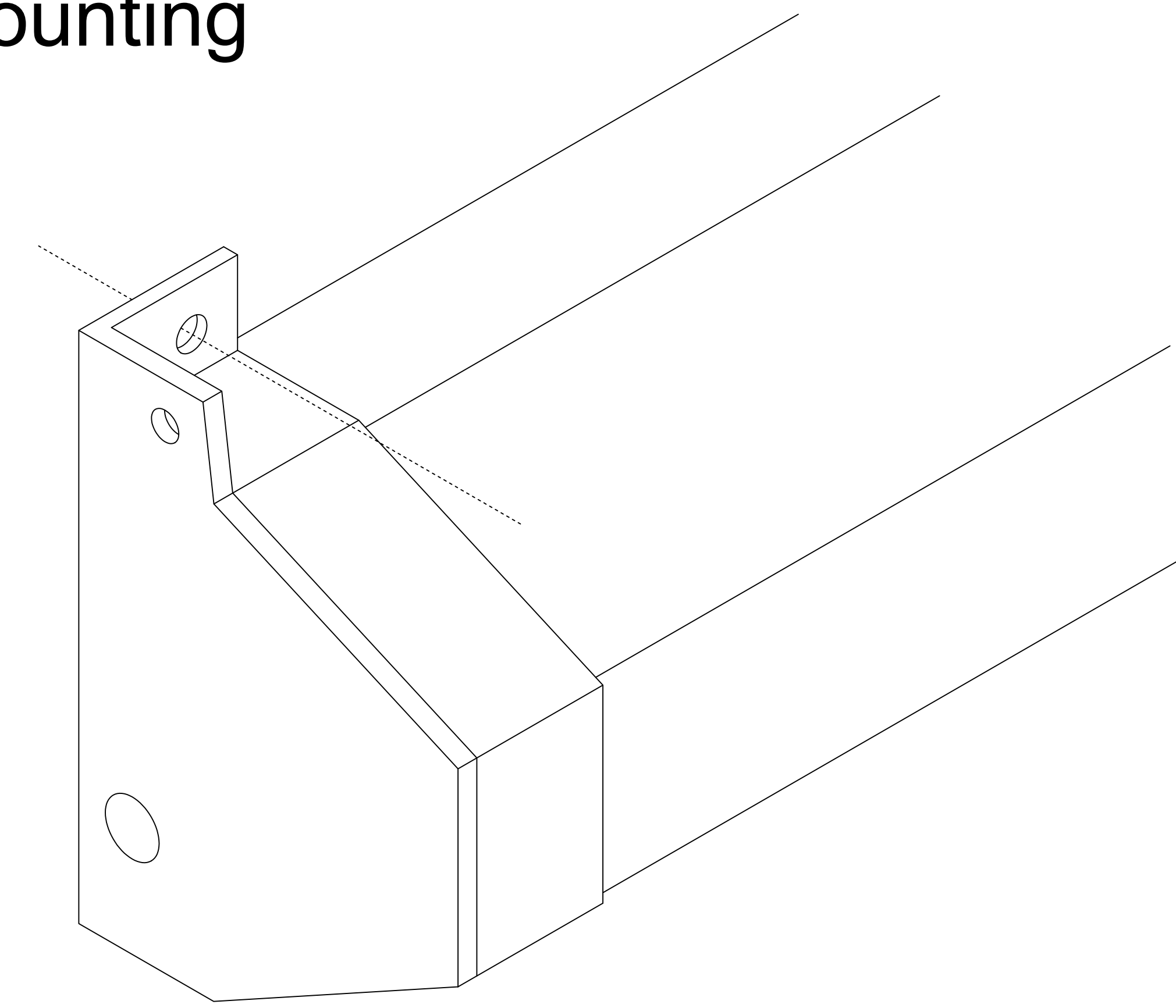

Ceiling Mounting

Screen may be hung from a hook mounted to ceiling

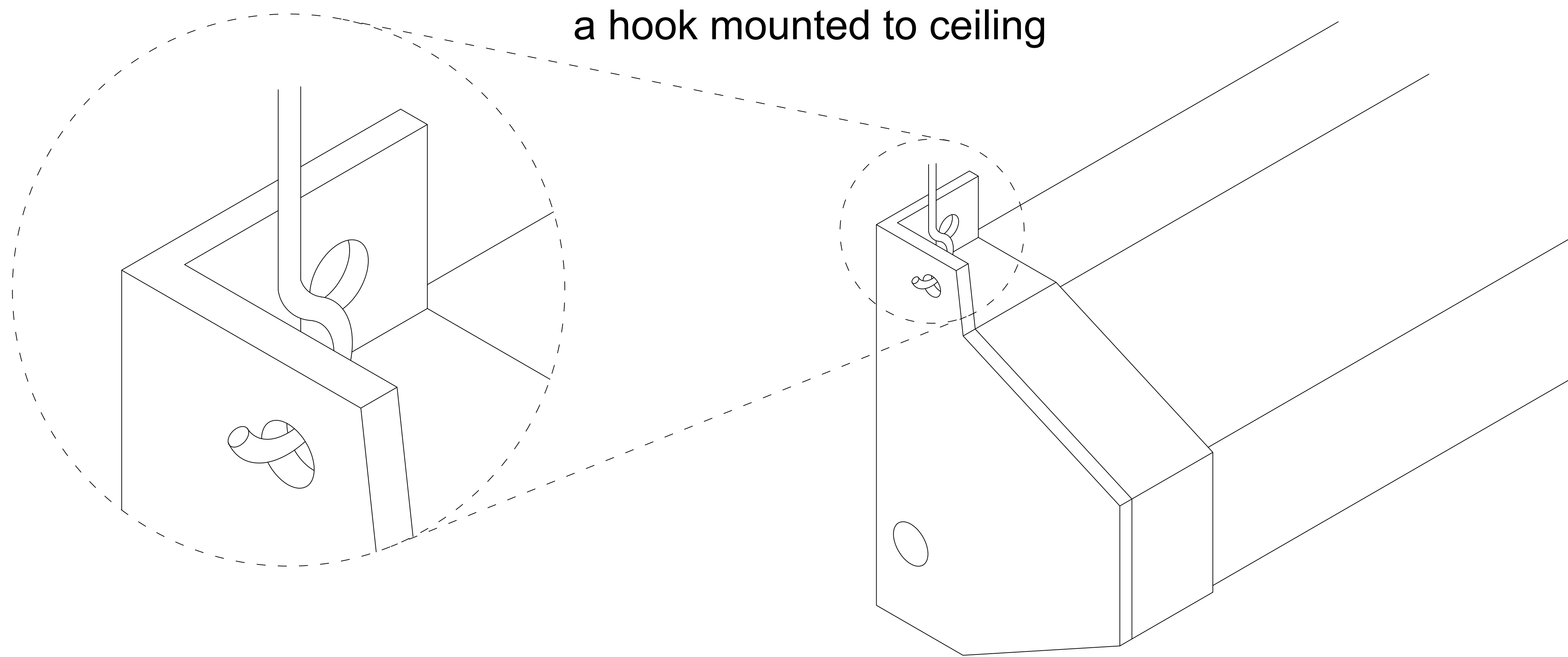

Professional Large Motorized
Screen 200" 16:9

Product Model: EV-LM-200-1.2

not to scale

Page 2 of 2