

ELUNEVISION	
EVO 8K Aurora NanoEdge LED Fixed Frame 165" 16:9	
Product model: EV8K-ZL-165-1.3	
Scale: 1:1	Page 1 of 3

LED Lighting Kit

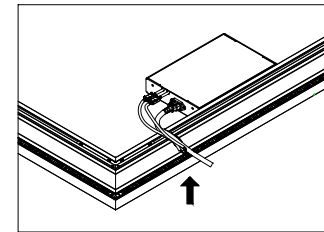
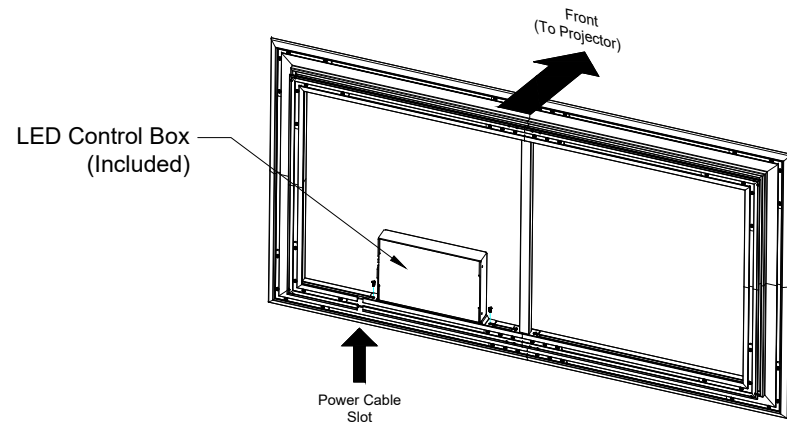

If the user does not have an available power supply directly behind the screen, a slot is available for the user to feed the power cable through the lower portion of the frame.

LED Strips (Included)

The LED strips are pre-installed on the frame. Users are only required to connect the corners and the LED control box during assembly process.

	
EVO 8K Aurora NanoEdge LED Fixed Frame 165" 16:9	
Product model: EV8K-ZL-165-1.3	
Not to Scale Not to Proportion	Page 2 of 3

Mounting Diagram

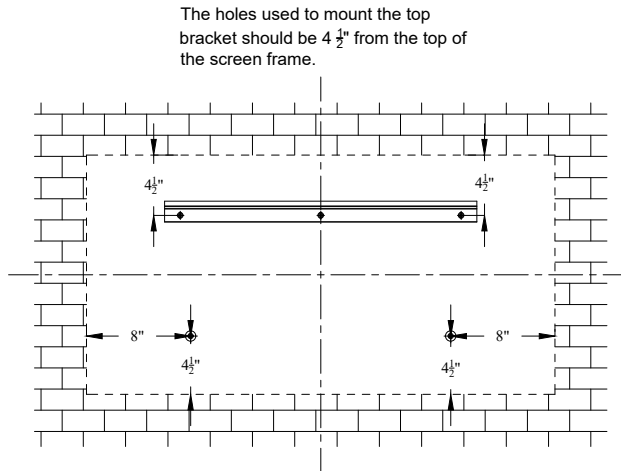

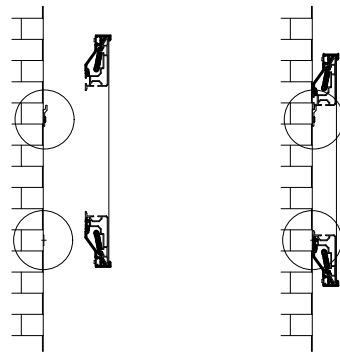

The holes used to mount the top bracket should be 4 1/2" from the top of the screen frame.

The holes used to mount the support magnets should be 4 1/2" from the bottom and 8" from the sides of the screen frame.

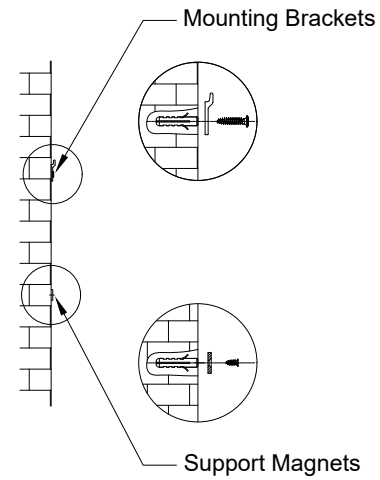

Support magnets are designed for users to keep their screens completely parallel to the wall they are mounted on. It can also be used to make the screen vertical when the user's wall is not flat.



	
EVO 8K Aurora NanoEdge LED Fixed Frame 165" 16:9	
Product model: EV8K-ZL-165-1.3	
Not to Scale Not to Proportion	Page 3 of 3